

# RADIOLOGY READING ROOM



[www.afcindustries.com](http://www.afcindustries.com)

## FURNITURE

# Contents







The widespread adoption of digital technologies as well as electronic medical records in the health care sector might lower costs and reduce errors, but it also may come with a hidden risk: increased musculoskeletal injuries among doctors and nurses. More and more research is pointing to the simple fact that Repetitive Stress Injuries are on the rise among this diverse workforce.

Since 1994, AFC Industries, Inc. has designed and manufactured a user centric line of ergonomically designed workstations, point-of-care carts, wall mounts and i-Centers™. These height adjustable units guarantee the right height for standing desks as well as traditional sitting levels which can accommodate a diverse healthcare workforce to enhance performance, comfort and satisfaction in the fast-paced modern work arena.

Whether you require assistance in choosing the appropriate components to configure a product or a complete room redesign, our staff of engineers and ergonomic design experts is available to provide you with the solutions you need for your projects.

Whatever your needs, AFC Industries, will manufacture your solution!

Remember too, that additional designs and models are available at [www.afcindustries.com](http://www.afcindustries.com).

|   |                                      |
|---|--------------------------------------|
|    | <b>INTERACTIVE WORKSTATIONS... 4</b> |
|    | <b>MOBILE DATA ACCESS..... 18</b>    |
|   | <b>WALL MOUNT SOLUTIONS .....28</b>  |
|  | <b>ACCESSORIES.....34</b>            |
|  | <b>SERVICE AND TECHNOLOGY....38</b>  |
|  | <b>STANDARD COLORS.....39</b>        |

# INTERACTIVE WORKSTATIONS



## Making work comfortable and productive

Ten years ago, back injuries in the workplace were most commonly attributed to heavy lifting. These days, the cause is more likely to be related to sitting at a desk for prolonged periods of time. The average age of carpal tunnel syndrome sufferers was late 30s to early 40s — it is now mid 20s. Furthermore, you can add the increasing incidence of neck, shoulder and arm pain; tension headaches; pain, swelling and stiffness of joints; eyestrain and vision problems; stress.

At AFC Industries, we take the science of work place ergonomics very seriously. We understand that different users have different needs. AFC workstations are electronically height-adjustable at the touch of a button. Independent adjustment of monitor height and focal length for optimal viewing. Digital readouts to preserve and easily return to your ideal settings for surface and monitor placement. Available with surface tilt and a host of valuable features.

Our flexible workstations come in a wide variety of sizes, shapes, multi-tiered designs, and color options that accommodate virtually any location and workplace need. Truly flexible, adjustable and they adapt to you!



## Features & Benefits

.....  
Electronic height adjustment of work surface  
.....

.....  
Electronic adjustment of monitor height and focal length  
.....

.....  
Pressurized and scratch-resistant long-lasting laminates in a variety of colors (for standard colors, see page 39)  
.....

.....  
Pop-up data ports and a built-in USB hub embedded in the work surface  
.....

.....  
Light and sound barrier partitions  
.....

.....  
Complete wall-to-wall installation services  
.....

## The Whitestone™

The Whitestone™ workstation is AFC's radiology dream station. Complete electronic adjustment capabilities are the foundation of this highly adaptable workstation — for surface height in sit or stand positions, surface tilt, and both vertical and horizontal adjustment of monitors.

The monitor brackets support large monitors weighing up to 100 lbs, responding to a growing interest in larger images. We have added acoustical properties to our wraparound privacy partition to reduce extraneous sounds and create a quieter environment for concentration. Multi-channel cable management keeps wires neat and unobtrusive.

### Electronic Monitor Mounts

LCD Monitor Arms on telescopic drives with electronic adjustment of monitors' height and focal length.

### Lighting

Adjustable LED backlight with dimmer control alleviates eye strain and improves readability of images.

### Electronic Height & Tilt

Easy electronic adjustment of the work surface height and tilt. Digital readout for desk height with four memory presets. This enables every user to preserve optimal settings.

### Data & Power Ports

Pop-up units include Ethernet network and parallel ports, as well as standard AC power outlets. Separate USB hubs include four ports.



### Soundproofing

Acoustical partitions help to cut down on the background noise and improve concentration.

### Cooling System

Monitors and CPU generate a lot of heat. Dissipate it quickly with the advanced environmental control system.

## Deluxe Ergo Tier™

We're pleased to offer well-designed, durable furniture that reduces the risk of strain and injury, while helping to maximize performance in the mission-critical healthcare role.

The Deluxe Ergo Tier™ workstation is designed to meet the need for easy electronic adjustment of the work surface height and tilt, as well as independent monitor positioning for height and focal length. The workstation can be enhanced with privacy partitions, shelving, computer storage, and other accessories.

### Electronic Monitor Mounts

LCD Monitor Arms on telescopic drives with electronic adjustment of monitors' height and focal length.

### Electronic Height & Tilt

Easy electronic adjustment of the work surface height and tilt. Digital readout for desk height with four memory presets. This enables every user to preserve optimal settings.



### Lighting

Our AmbiTask Light Combo can be controlled with independent dimmer switches for total operator regulation of workstation lighting.

### Power and USB Hubs

Connect secondary devices with our pop-up data power port and USB hubs.

### Laminate finish

Pressurized and scratch-resistant long-lasting laminates in a variety of colors (see page 39 for standard colors or call us for any other color).

## Ergo Tier™

AFC's flexible workstations are designed with ergonomic intelligence for a wide range of users and needs. They help to reduce stress and injuries, and allow radiologists and healthcare professionals work more comfortably and effectively.

The Ergo Tier™ has independent, electronic height adjustment of the work surface and monitor platform. This is but one of the 6 monitor platform choices available to you (see next page for descriptions).

### Electronic Monitor Mounts

LCD Monitor Arms on telescopic drives with electronic adjustment of monitors' height. Electronic or manual adjustment of monitor forward/backward motion.

### Electronic Height

Electronic adjustment of work surface height. Digital readout for desk height with four memory presets.

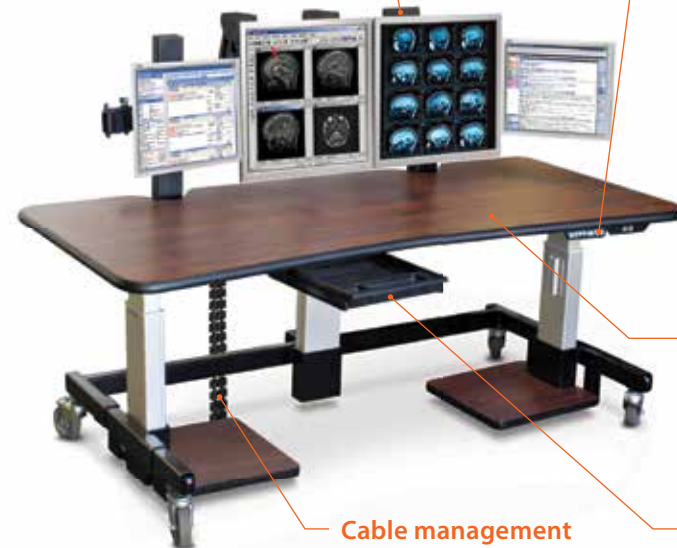

### Laminate finish

Pressurized and scratch-resistant long-lasting laminates in a variety of colors.

### Cable management

Multi-channel wire manager keeps wires neat and unobtrusive and allows for important separation of power and electric wiring.

### Accessories

A pencil drawer, split shelves and additional accessories are also available. See pages 34-37 or our web site for details.

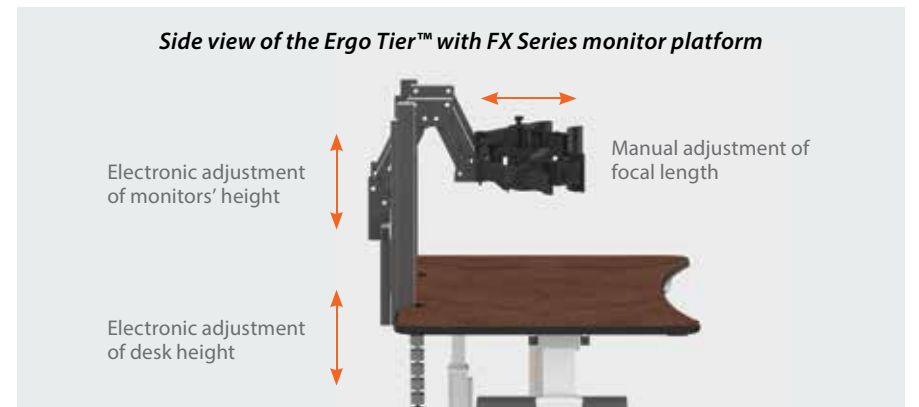
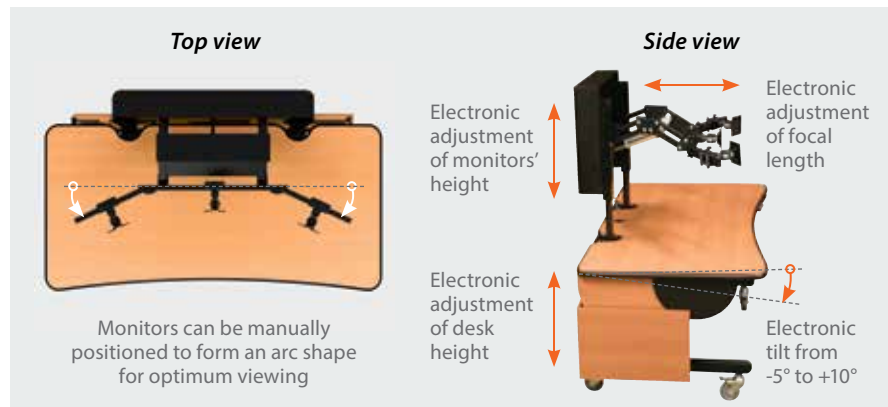

Work Surface Shapes

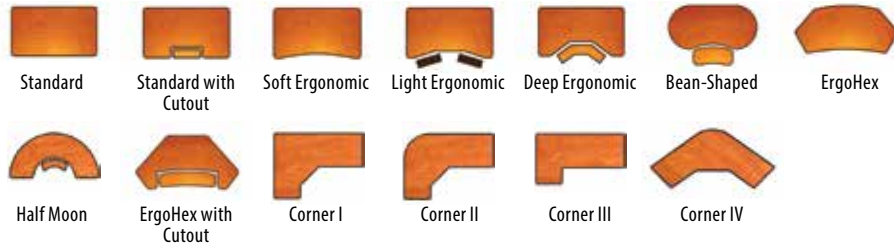

Electronically Adjustable Monitor Platforms



**EFX Series**

- Electronic adjustment of monitor height
- Electronic adjustment of monitor focal length
- Side wings allow outer monitors to form an arc



**FX Series**

- Electronic adjustment of monitor height
- Manual adjustment of monitor focal length
- Side wings allow outer monitors to form an arc



**RX Series**

- Electronic adjustment of monitor height
- Horizontal sliding of each monitor on the track



**ZX Series**

- Electronic adjustment of monitor height
- Manual adjustment of each monitor focal length
- Horizontal sliding of each monitor on the track



**SW Series**

- Electronic height adjustment of slatwall
- Manual adjustment of monitor focal length
- Horizontal sliding of each monitor on the slatwall



**TS Series**

- Electronic height adjustment of monitor shelf
- Monitors can be free-standing or permanently attached.

You can combine one of our electronically adjustable monitor platforms with any work surface shape shown at the top of this page.

Sample Configurations

**A. Ergo Tier™ EFX 60"W x 34"D:**

- Electronic adjustment of work surface height
- Electronic adjustment of monitor height and focal length
- Monitor platform on telescopic drives with two monitor holders # AFC2530 for large screens
- Adjustable CPU Holder # CPU 13-25



**B. Ergo Tier™ SW 60"W x 30"D:**

- Independent electronic height adjustment of work surface and monitors
- 10"-high slatwall on telescopic drives with a 12-inch upward stroke
- Two Z-series Monitor Arms #AFCZ666-01
- Two Z-series Monitor Arms #AFCZ566-01 on 20" vertical track
- LED Task Light # TAL400
- Pop-up data port & USB hub
- Two desk-mount CPU holders # CPU-01



NEW

**C. Ergo Tier™ TS 60"W x 30"W:**

- Independent electronic height adjustment of work surface and monitors
- Monitor shelf on telescopic drives with a 12-inch upward stroke
- 3-outlet power strip
- Desk-mount CPU holder # CPU-01



NEW

**D. Ergo Tier™ ZX 60"W x 36"D:**

- Independent electronic height adjustment of work surface and monitor platform
- Three Z-series Monitor Arms sliding left-right in 56-inch track mounted on telescopic drives # AFCERGO03\_Z
- Acoustical partition
- Two wire managers # WMF100



## Dual Tier™

The Dual Tier™ has two independently adjustable surfaces. With the simple touch of a button you can adjust the height of the monitors and work surface from a seated to a standing position. In the bifocal setting, the monitors are lower than the work surface, ensuring a comfortable viewing angle. This flexibility delivers optimum body positioning and comfort.

### Monitor Mounts

Our Z-series arms with its 20-inch extension allow you to position your monitors at any viewing level, angle and depth from the viewer.

### Electronic Height

Independent electronic adjustment of both tiers. Digital readout for each tier's height with four memory presets to preserve and easily return to your ideal settings.



### Modesty Panels

Provide privacy and structural support in colors to match the work surface.



Both tiers at same height



Raised back tier



Bifocal position

## Work Surface Shapes

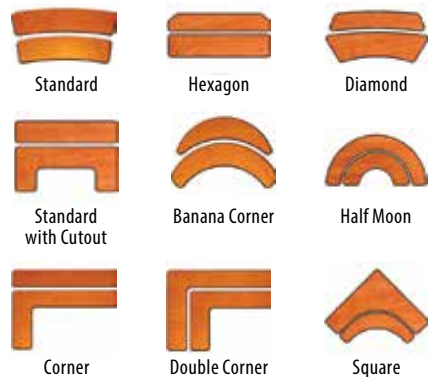

Configure your own Dual Tier™ with our INTERACTIVE BUILDER at [www.afcindustries.com/dualtier](http://www.afcindustries.com/dualtier)

## Sample Configurations

### A. Dual Tier™ 64"W x 64"D:

- Independent electronic height adjustment of both tiers
- Top shelf
- Z-series Monitor Arm # AFCZ588-02
- Back modesty panel
- Corner split bottom shelf



### B. Dual Tier™ 72"W x 36"D:

- Independent electronic height adjustment of both tiers
- Monitor Arm # AFCRAILZ03-3CLAMP
- 16-inch deep bottom shelf with a center cutout for the metal foot rest



### C. Dual Tier™ 72"W x 72"D:

- Independent electronic height adjustment of both tiers
- Two Z-series Monitor Arms # AFCZ566-02
- Two Wire Managers # WMF100
- Full bottom shelf



### D. Dual Tier™ 93"W x 46"D:

- Independent electronic height adjustment of both tiers
- Z-series arm for one large flat screen monitor #AFC666-01
- Z-series arm for two flat screen monitors # AFCZ588-02
- Adjustable dictation arm # TA003B
- Three split bottom shelves



## Single Tier™

Our Single Tier™ is the perfect choice when you need to adjust the workstation to your own size and preferences and comes in a wide variety of configurations, sizes and colors. Electronic height adjustment makes the Single Tier™ desk versatile for multiple users.

Select a work surface shape from page 8, or have us customize a surface shape that best fits your requirements. Complete your desk with shelving, computer storage, monitor arms, CPU holders, lighting, and other accessories (see page 34 for more information).

### Electronic Height

Electronic adjustment of work surface height. Digital readout for desk height with four memory presets.

### Monitor Mounts

The slatwall monitor system lets the user slide monitor arms horizontally.

### Slatwall

10"-high slatwall is a great way to attach a multitude of accessories.



### Swinglift Keyboard Arm

Slim and low profile of the arm maximizes leg room beneath the keyboard tray. Paddle actuator allows single hand height adjustment. Lever (or knob) provides 15° positive and negative tilt adjustment.

### Lockable Storage

Lockable technology cabinets with front and rear hinged doors provide full access to multiple CPUs.

### Side extensions

Semi-round foldable work surface extensions create an additional work area.

## Sample Configurations

### A. Single Tier™ 60"W x 36"D:

- Electronic height adjustment of work surface
- Three Z-series Monitor Arms # AFCZ566-01 on 56" track on three poles
- Swinglift Keyboard Arm #KA7001
- Full bottom shelf with Foot Rest #FR010
- 4-inch casters #CAS-4



### B. Single Tier™ 60"W x 36"D:

- Electronic height adjustment of work surface
- Three clamp-mount Z-series Monitor Arms # AFCZ566-03
- Adjustable CPU Holder # CPU 13-25



### C. Single Tier™ 84"W x 36"D:

- Electronic height adjustment of work surface
- Articulating Arm for four monitors # AFCFLEXO\_4
- Keyboard Arm # KA6000 with tray # TR3000
- Adjustable CPU Holder # CPU 13-25
- Back and side modesty panels



### D. Single Tier™ 96"W x 30"D:

- Electronic height adjustment of work surface
- Articulating Arm for five monitors # AFCFLEXO\_5
- Pencil Drawer # PD002
- Two desk-mount CPU Holders # CPU-01
- Full bottom shelf



**E. Single Tier™ 56"W x 54"W:**

- Electronic height adjustment of work surface
- Phone Arm # TA002
- Retractable Pencil Drawer # PD002
- Partition
- Fluorescent Under-Shelf Light # TAL300F



**F. Single Tier™ 72"W x 72"W:**

- Electronic height adjustment of work surface
- Flipper cabinet with three doors
- Three Monitor Arms # AFC02
- Keyboard Arm # KA6000 with tray # TR3000
- Two Phone Arms # TA002
- Two split bottom shelves
- Mobile Film Box # FB-100
- Metal Film Box # FB-200



**G. Single Tier™ 96"W x 36"D:**

- Electronic height adjustment of work surface
- Z-series Arms # AFCZ500-02 and # AFCZ500-03
- AmbiTask Light Combo # AMBL001
- Swinglift keyboard arm
- Partition with removable lower metal panel for back CPU access
- CPU enclosure with mobile platform



Mobile CPU enclosure allows for both front and back CPU access



Configure your own Single Tier™ with our INTERACTIVE BUILDER at [www.afcindustries.com/singletier](http://www.afcindustries.com/singletier)

**IntelliCart™**

We also offer non-electric desks. The IntelliCart™ features cutting-edge design and flexibility, and gives you the versatility and mobility you have been looking for. The carts have 16-inch deep top shelf and 18-inch deep bottom shelf edged with bumper molding. The work surface is manually height-adjustable in one-inch increments. Its soothing, fluid lines bring a relaxing touch to busy work environments. With an elegant yet simple design, it is a strong and comfortable workstation that will last a lifetime.



**Laminate finish**

Pressurized and scratch-resistant long-lasting laminates in a variety of colors.

**Adjustable**

Reinforced steel upright with concealed mounting holes in one inch increments to adjust surface's height.

**Customizable**

Our engineers are always available to assist you with the design elements you need.

**Sample Configurations**

**A. IntelliCart™ 36"W x 30"D:**

- Top shelf
- Clamp-mount Monitor Arm # AFC02
- Swinglift Keyboard Arm # KA7001
- Bottom shelf



Swinglift keyboard arm in seated position with tilt



Swinglift keyboard arm in standing position

**B. IntelliCart™ 48"W x 30"D:**

- Flipper cabinet with two doors
- Middle shelf
- Swinglift Keyboard Arm # KA7001
- Handle
- Bottom shelf



Swinglift keyboard arm in standing position with tilt



## SmartCart™

The versatility offered by AFC's SmartCart™ makes it a wonderful addition to any work environment. With virtually limitless configurations and customization, this cart fits your needs perfectly.

All SmartCarts™ are exclusively built from reinforced steel with pressurized scratch-resistant laminate surfaces, making them extremely strong and durable. Select a work surface shape (see page 8) or let us create the SmartCart™ that is right for you.

### Monitor Mounts

Our Z-series arm with its 20-inch extension allow you to position your monitors at any viewing level, angle and depth from the viewer.



### Slatwall

Four 5" high slatwalls are a great way to attach accessories.



### Privacy Partitions

The sound-absorbing partitions also prevent interference from the light sources and have removable lower metal panels to access CPUs from rear.

### Storage

Cabinet enclosure with mesh doors provide ample room for multiple CPUs and support both front and rear access, enabling easy installation and service.



Configure your own SmartCart™ with our INTERACTIVE BUILDER at [www.afcindustries.com/smartcart](http://www.afcindustries.com/smartcart)

## Sample Configurations

### A. SmartCart™ 60"W x 36"D:

- Z-series Monitor Arms # AFCZ588-02 and # AFCZ588-01
- Swinglift keyboard arm
- Task light # TAL200A with dimmer
- Two wire managers # WMF100
- Full bottom shelf
- Two CPU cradles # CPU-07



### B. SmartCart™ 93"W x 46"D:

- Half-moon work surface shape edged with bumper molding
- Three clamp-mount Z-arms # AFCZ588-01
- Keyboard Arm # KA6000 with Keyboard Tray # TR2000
- Full bottom shelf



### C. SmartCart™ 96"W x 72"W:

- Flipper cabinet with two doors
- Middle shelf
- Z-series monitor arm # AFCZ588-2
- Under-desk-mount pedestal with drawer and file
- Bottom shelf



### D. X-Series Desk™ 96"W x 72"W:

- 10" high slatwalls
- Z-series Monitor Arms # AFCZ588-02 and # AFCZ588-01
- Slatwall-mount shelves
- Slatwall-mount document holders
- Adjustable CPU holders # CPU 13-25
- Modesty panels



# MOBILE DATA ACCESS



## Providing data where and whenever it's needed

Mobile carts bring critical information to Point-of-Care locations throughout Healthcare facilities. Whether it involves admissions, pharmaceutical, radiological or telehealth video conferencing, daily patient care decisions must be accurately made and supported by the most current data available. AFC's array of durable mobile carts is designed to meet this growing need, while incorporating important ergonomic features that make them adaptable to any user.

Our height adjustable units are available with small footprints for easy maneuvering in tight places. Security features protect both sensitive patient information and computer equipment and our carts are built from materials for thorough disinfection. Long-lasting batteries (Hot Swappable/LiFe/SLA Power Supply) can be loaded so that carts can move from area to area, without being connected to electrical outlets, providing uninterrupted power to your workstation wherever, and whenever you need it.

Whatever your need is, AFC can build a mobile cart solution for you.

## Teleradiology Is Here To Stay

The debate rages on as to whether Teleradiology is a help or hindrance to traditional Radiology departments and practices.

The emergence of Healthcare IT and the most recent healthcare reforms (over 45 million uninsured Americans will now have access to healthcare insurance coverage) will put additional pressures onto already stretched resources and physicians. This, in turn, will fuel the growth of Telemedicine/Teleradiology practices to allow the system to obtain the additional radiology services that are required.

AFC Industries has created highly mobile and ergonomic solutions especially for this growing discipline. From something as simple as discussing a case over the telephone, or as complex as using satellite technology to conduct a real-time consultation between medical specialists in

two different countries, our Teleradiology Carts can fit all situations. Available in a variety of sizes and shapes and equipped with camera holders, these units have become a mainstay in the transference and sharing of medical imagery.



## Teleradiology Video Cart PC910-303

Our newest **electronically height adjustable** teleradiology cart PC910-303 provides a fully integrated, mobile computing workstation designed for enhanced efficiency when health services through advanced applications are necessary.

Medical and non-medical devices can be easily connected to the carts systems' enabling high definition, real-time images to be shared providing the best diagnosis and care regardless of geographical or physical constraints. The combination of a compact design with a strong ergonomic focus makes this cart ideal for point-of-care applications.





### Teleradiology Cart TMC300

The telemedicine cart TMC300 is a **pneumatically height adjustable** unit with an optional battery power source for true mobility. It is available with standard VESA-compliant mounting brackets (75/100), a locking drawer, camera mount and room for an all-in-one or a thin client computer. Sleek, efficient and easy to move with the integrated handles and four 4-inch casters.



### Teleradiology Cart XPC1926

The XPC1926 cart comes with two **pneumatically height adjustable** surfaces. Fully articulating VESA-compliant monitor arms, a spacious 15"W x 11"D x 4"H locking drawer, retractable keyboard tray, enclosure for CPU and the battery power source; and camera mount makes this cart an ideal unit for video conferencing.



### Plasma Cart™ XLCD300-01

The Plasma Cart™ is ideal for meetings, presentations, seminars, conferences and signage. Accommodating up to a 55" flat screen, this stable unit is a perfect solution for data and video access as you bring your large flat screen and necessary electronic equipment to where it is needed. All the components of the Plasma Cart are **height adjustable**. Internal wire management is built in behind easy-to-remove access panels.



### Pole Cart™ MPC200

A truly customized item. The Pole Cart™ begins as a blank canvas with a wheeled base and main pole assembly. Everything you select to include becomes **height adjustable** and **can rotate 360° around the pole**. Monitors, CPU holders, keyboard trays, camera mounts, additional shelves, scanner and speaker holders and more. Built-in wire management keeps everything neat and tidy. A product that will meet your needs because you "design it".

## PC Cart™

Our PC (Point-of-Care) Carts™ are designed for maximum flexibility and streamlined movement. They enable physicians to bring advanced computer technology to the bedside, operating room and any other location where patients will benefit from today's medical computer applications.

The PC Carts™ feature a low profile, small footprint, **pneumatic** (optional electronic) **height adjustment**, and support all-in-one computers as well as separate thin client and monitor. For maximum portability, the carts can accommodate a battery power source (go to [www.afcindustries.com/Batteries](http://www.afcindustries.com/Batteries) for power supply options).

### Features and Benefits

Pneumatic height adjustment

Thorough disinfection for "clean room" use

Supports all-in-one computer as well as separate thin client and monitor

Mounting for all-in-one computer or standard monitor VESA (75/100)

Phenolic, HDPE<sup>1</sup>, or laminate work surface

Seamless integration of handles into the work surface on all four corners for easy grip from any user position



### Optional

Electronic height adjustment

Keyless electronic lock for utility drawer and divider to facilitate administration of care in two-patient rooms

HDPE retractable keyboard tray with ergonomic negative and positive tilt and swivel

Power supply, wire manager, mouse holder, wire basket, scanner holder, and additional accessories available

Antimicrobial finish (see page 38 for more information)



<sup>1</sup> High-density polyethylene (see inside back cover for more information)

## PC Cart™ 910

The PC Cart™ 910 combines a streamlined look and enhanced functionality with the hallmark durability and ergonomic design of AFC's mobile work stations.

With an all-in-one computer, the height-adjustable PC 910 offers a battery that can run for up to 25 hours before recharging. UL 60601-1 compliant, it is safe to use throughout facilities. Fleet management software allows for IT monitoring, management, and programming of carts for location, battery status, and scheduling of computer shutdown, recharging and maintenance.

### Monitor Mounts

Supports all-in-one computer as well as separate thin client and standard monitor VESA (75/100).

### Easy Grip

Cutout handles on all corners facilitate grip and access from any user position.

### Cable Management

Multi-channel wire manager keeps wires neat and unobtrusive

### Mobility

Four 5-inch casters with round tread wheels for ease of movement.

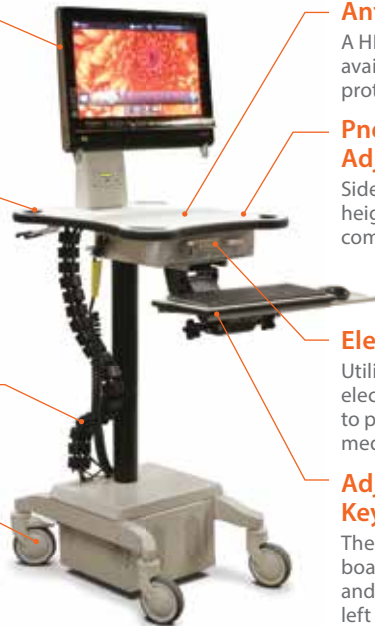

### Antimicrobial Finish

A HDPE work surface now available with antimicrobial protection.

### Pneumatic Height Adjustment

Side lever easily adjusts the height of the work surface to be comfortable for the end user.

### Electronic Lock

Utility drawer with a keyless electronic lock and divider to protect documents and medications.

### Adjustable Keyboard Tray

The retractable phenolic keyboard tray features tilt, swivel, and a sliding mouse tray for both left and right-handed users.



### Standard Colors



Gray Putty Black

### HDPE Colors



Gray Black<sup>1</sup>

### Specifications

| Sizes         | Width | Depth |
|---------------|-------|-------|
| Work surface  | 24"   | 24"   |
| Footprint     | 20"   | 24"   |
| Keyboard tray | 19"   | 8"    |

Height of work surface from the floor: ~30" to 42"

<sup>1</sup> Available with antimicrobial finish

## PC Cart™ 800

This multi-purpose and functional cart is ideal for all healthcare business and service sectors. The PC Cart™ 800 has a rectangular base for stability.

Completely modular. Select from our full range of monitor arms, CPU holders, keyboard trays and other accessories to complete your configuration. Available in several colors to match most color schemes or to stand out for easy identification.

### Monitor Mounts

Clamp-mount Z-series arm with its 20-inch extension allow you to position your monitors at any viewing level, angle and depth from the viewer.

### Choice of Work Surface

Choose from a laminate, phenolic or HPDE work surface.

### Pneumatic Height Adjustment

Side lever easily adjusts the height of the work surface to be comfortable for the end user.

### Rear Handle

Rear mounted handle provides control and ease of maneuverability.

### Mobility

Four-inch dual casters. The front two are locking for rigid stability when you need it.



### Laminate Colors



### HDPE Colors



<sup>1</sup> Available with antimicrobial finish

### Specifications

| Sizes         | Width   | Depth |
|---------------|---------|-------|
| Work surface  | 22 1/2" | 20"   |
| Footprint     | 19"     | 20"   |
| Keyboard tray | 18"     | 8"    |

Height of work surface from the floor: ~30" to 42"

### Alternate Configuration



#### A. PC Cart™ 800:

- Pneumatic height adjustment of work surface
- HDPE work surface with two built-in handles
- Grommet-mount Monitor Arm # AFCPOLE2MH-1
- Retractable keyboard tray # KB03
- Base-mount CPU holder # CPU-99

## Laptop Cart LPC750

Our highly adaptable LPC750 is designed to hold laptops. This cart features **pneumatic height adjustment** and offers a compact look. Our smallest footprint and a base height of less than 6 inches makes it suitable for small work areas. It's specially designed star-shaped base with 3-inch wheels delivers smooth and fluid mobility while maintaining its overall stability. See all of our designs at [www.afcindustries.com](http://www.afcindustries.com).

### Secure Laptop Cover

Half-inch thick laptop cover using tamper proof screws.

### Front & Back Handles

Integrated handles in the front and back for ease of maneuverability.

### Retractable Keyboard Tray

The retractable metal keyboard tray and a sliding HDPE mouse tray with friction lock when pulled out or in.

### Accessories

Height adjustable brick holder with cutout at the ends, metal storage bin, and wire basket.



### Antimicrobial Finish

Major contact surfaces are made of HDPE and available with antimicrobial protection.

### Pneumatic Height Adjustment

Side lever easily adjusts the height of the work surface to be comfortable for the end user.

### Small Footprint

Star-shaped base with five 3-inch wheels (the front two are locking).

## Features and Benefits

### Pneumatic height adjustment

### Thorough disinfection for "clean room" use

### Built from cold-rolled steel with epoxy-powder-coated finish

### Retractable metal keyboard tray with sliding mouse tray

## Optional

### Lockable laptop cover

### Retractable power cord

### Hook for cable

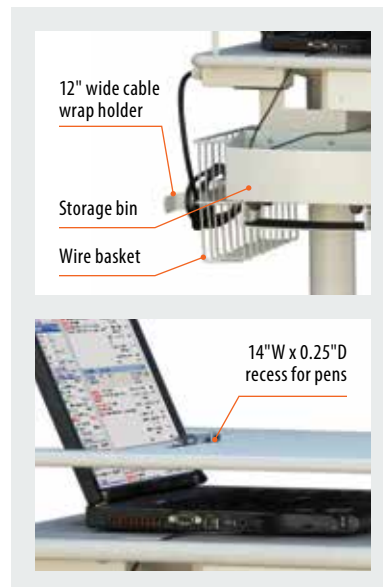

## HDPE Colors

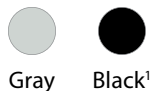

Gray Black<sup>1</sup>

<sup>1</sup> Available with antimicrobial finish

## Specifications

| Sizes         | Width        | Depth |
|---------------|--------------|-------|
| Work surface  | 21"          | 12"   |
| Footprint     | 22" diameter |       |
| Keyboard tray | 18"          | 8 ½"  |

Height of work surface from the floor: ~28" to 44"

## Tablet Cart TBC150-201

NEW

At AFC Industries we are committed to creating end-user solutions driven by new technologies. The latest advancements in data access mobility point to the handheld tablet as an increasing popular device. Far more flexible and bedside-friendly than even small laptops, these handheld devices promote safer, better, and faster care by enabling doctors and other caregivers to educate and involve their patients in the process.

The AFC tablet cart TBC150-201 is specifically created to hold a tablet or iPad™. You will appreciate this carts' height adjustment, its stability and ease of movement, the small footprint and more.

### Secure Tablet Holder

Tablet holder with security screws and tether cable.

### Secure Docking Station Holder

Docking station holder with security screws.

### Square Footprint

Aluminum square base with additional weight for increased stability.

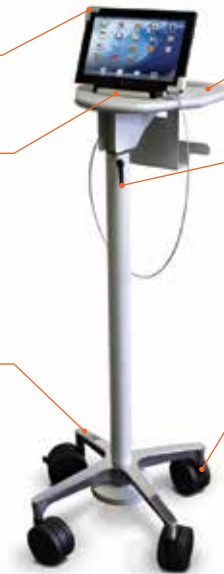

### Antimicrobial Finish

HDPE work surface is available with antimicrobial protection.

### Height Adjustment

Side lever easily adjusts the height of the work surface.

### Mobility

Four 4-inch casters (two are locking) for ease of movement.

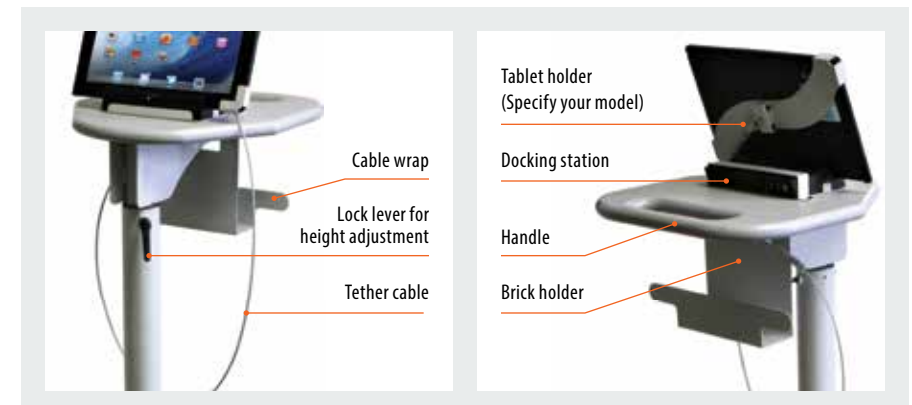

## HDPE Colors

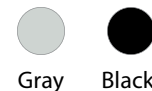

Gray Black<sup>1</sup>

<sup>1</sup> Available with antimicrobial finish

## Specifications

| Sizes        | Width | Depth |
|--------------|-------|-------|
| Work surface | 12 ½" | 13 ½" |
| Footprint    | 19"   |       |

Height of work surface from the floor: ~33.5" to 44.5"

## Telescopic Cart™

The Telescopic Cart™ is designed to accommodate tight spaces. The work surface is **electronically height-adjustable** to enhance comfort and ease of use, whether the operator is seated or standing. Available in different width and depth combinations, the cart can accommodate up to two flat panel monitors.

All sizes are customizable with grommet-mount or clamp-style monitor arms, multiple laminate finishes and colors (see page 39), keyboard arms and trays, and larger casters for two additional inches of height.

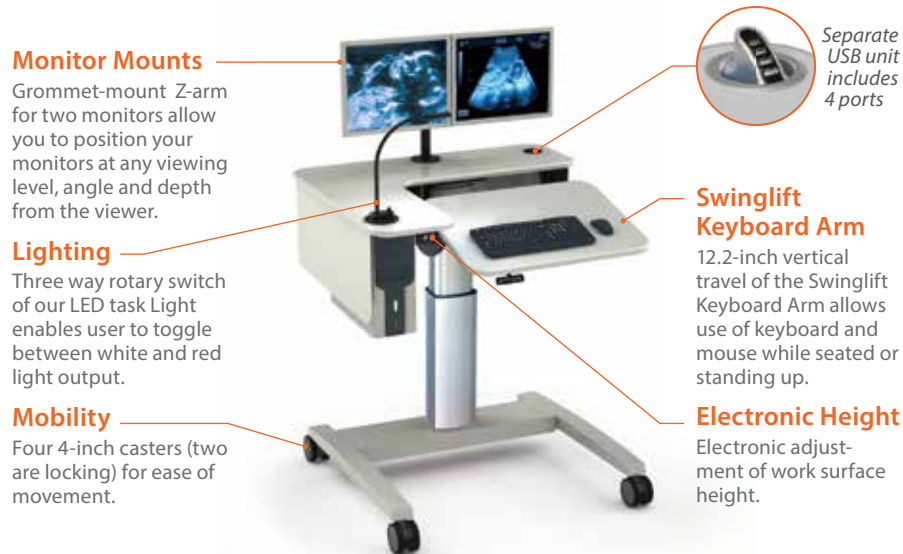

### Features & Benefits

Electronic height adjustment of work surface

Particle-board-core top with your choice of high-pressure laminate finish (for standard colors, see page 39)

Cold-rolled 11-gauge steel frame with epoxy-powder-coated finish for durability

### Optional

Electronic tilt of work surface

Chemical-resistant phenolic top and bottom surfaces

USB hub embedded in the work surface and other accessories (see page 35)

### Work Surface Shapes

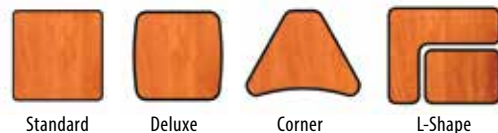

### Specifications

| Work Surface Shapes | Width         | Depth         |
|---------------------|---------------|---------------|
| Standard            | 24", 30", 36" | 24", 30", 36" |
| Deluxe              | 24", 30", 36" | 24", 30", 36" |
| Corner              | 24", 30", 36" | 24", 30", 36" |
| L-Shape             | 36", 42"      | 24", 30", 36" |

Height of work surface from the floor: 30" to 46"

### Sample Configurations

#### A. Telescopic Cart™ 36"W x 24"D:

- Electronic height adjustment of work surface
- Deluxe work surface shape
- Two grommet-mount monitor arms # AFC02
- Keyboard Arm # KA6000 with Keyboard Tray # TR2000
- Bottom shelf with cutout



#### B. Telescopic Cart™ 30"W x 30"D:

- Electronic height adjustment of work surface
- Standard work surface shape
- Chemical-resistant phenolic work surface and bottom shelf
- Grommet-mount twin Monitor Arm # AFCPOLE2MH-1



#### C. Telescopic Cart™ 24"W x 24"D:

- Electronic height adjustment of work surface
- Deluxe work surface shape
- Clamp-mount Monitor Arm # AFCPOLE
- Retractable Keyboard Tray # KB01
- Adjustable CPU Holder
- Wire Basket # WB-100
- Wire Manager # WMF100
- Base-mount CPU Holder # CPU-99



#### D. Telescopic Cart™ 30"W x 24"D:

- Electronic height adjustment of work surface
- Corner work surface shape
- Keyboard Arm # KA6000 and Tray # TR2000 with sliding mouse tray



Configure your own Telescopic Cart™ with our INTERACTIVE BUILDER at [www.afcindustries.com/telescopiccart](http://www.afcindustries.com/telescopiccart)

# WALL MOUNT SOLUTIONS



## Making the most of limited-space

High traffic areas. Tight places. Operating rooms and emergency rooms. Inside and outside patient rooms. These are just some of the areas that are perfectly suited for AFC's variety of mounting solutions. Height-adjustable versions for seated or standing positions. Adaptable to any user. Making empty wall space productive.

Decentralizing the availability of data for a greater return on investment in plant and human capital.

## Combo Arms AFC7808 and AFC7810 Series

Our flexible AFC7808 and AFC7810 series offer height-adjustable, low-profile, user-friendly solutions for access to electronic records where space is at a premium. The wall mount accommodates most operators, in sit-to-stand positions. When not in use, it folds up neatly to the wall, tucked away and unobtrusive.

The AFC 7810 arm has an additional 10-inch vertical monitor adjustment, as well as, 35° of forward and backward tilt to make sitting or standing viewing more comfortable.

### Pneumatic Height Adjustment

The arm is pneumatically height adjustable within a 12-inch range and can be locked in any position you chose.

### Flexible

Arm vertically adjusts on wall mounting track and has full range of swivel motion at each joint to accommodate different positions and applications.

### Integrated Wire Management

Integrated wire management for clean, concealed and neat routing of cables.

### Monitor Mounts

VESA 75/100 compliant monitor bracket with horizontal and vertical tilt and 3-inch range of height adjustment.

### Antimicrobial Finish

Light-weight aluminum construction with anti-microbial coatings for thorough disinfection.

### Low Profile

Keyboard tray with handle and sliding mouse tray easily folds up, saving space when not in use.

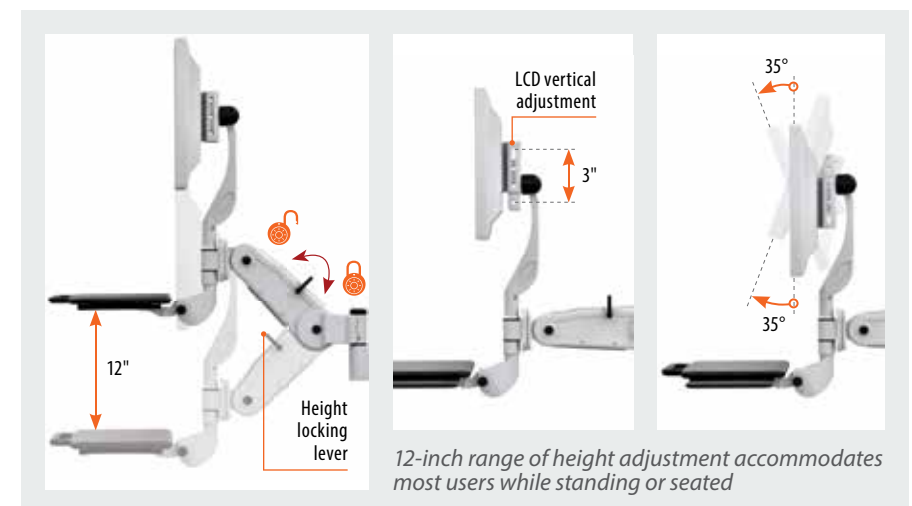
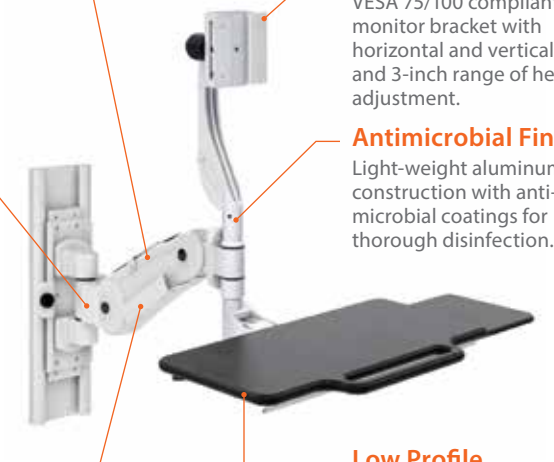

### A. Pneumatically height-adjustable arm AFC7808 on 18-inch wall track

Features & Benefits

- Light-weight aluminum construction for easy operation
- Anti-microbial coatings for thorough disinfection and safe use throughout medical facilities
- Sit-to-stand work positions
- Height locking mechanism at any position for safety, stability, and varying loads
- Full range of swivel motion at each joint
- Keyboard folds for low profile and has a safety lock
- 12-inch range of height adjustment accommodates most users
- 34" when fully extended from the wall
- 8.5" when retracted and folded to the wall
- VESA 75/100 compliant monitor bracket with horizontal and vertical tilt and 3-inch range of height adjustment
- Integrated wire management

Optional

- Can be mounted directly on a wall or desk
- Supplemental 12" or 20" extension arm
- Wall mounted track with safety stoppers on both ends (from 18" up to 84" long with one-inch increment)

Color

- Standard color: Gray (call for custom colors)

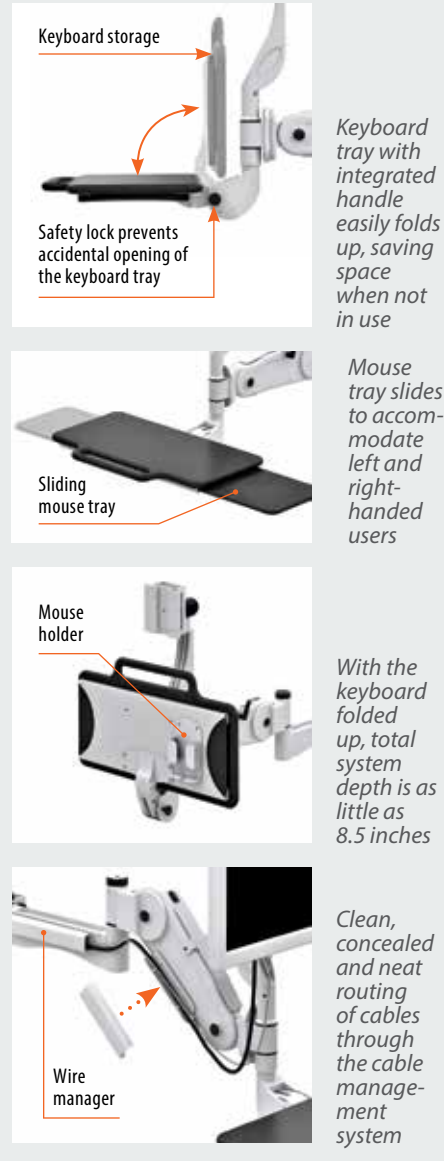

B. Combo arm AFC7808 with 12-inch extension on 18-inch wall track

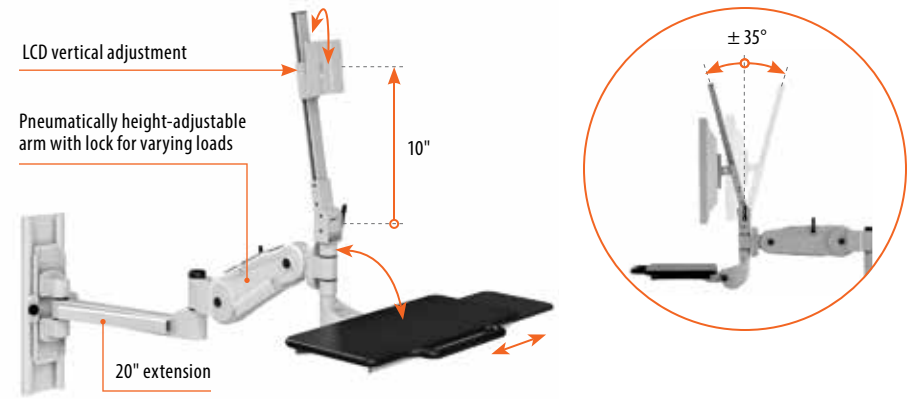

C. Combo arm AFC7810 with 20-inch extension on 18-inch wall track

Mounting Options



More Mounting Solutions with AFC7808 Series

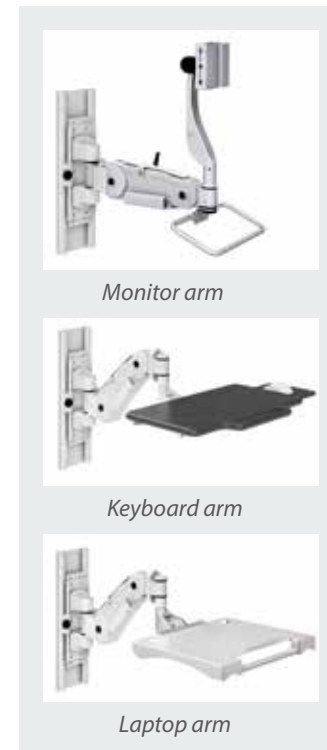



## Wall Mounts

AFC Wall Mounts are the perfect space-saving solution for areas that require data access in place of a bulky computer desk or traditional workstation. By mounting the workstations to the wall, you are able to free up and provide uncluttered floor space in exam rooms, hallways, public spaces and other high traffic areas where computer access for multiple users is necessary.

Mounted directly to a wall for a fixed height, or height adjustable when used with our wall mount track, our solutions provide you with the options you need to ergonomically get the job done and protect your workforce.

### Features and Benefits

Wall track with safety stoppers on both ends (from 18" up to 84" long with one-inch increment)

All components are individually and easily adjustable in increments of 2 inches

VESA-compliant monitor holder that can be adjusted from portrait to landscape view and tilted to avoid glare

Foldable and retractable keyboard arm with sliding mouse tray

Adjustable CPU holder

### Optional

Horizontal or vertical positioning

Double monitor holder on single track

Horizontal track for multiple monitors

Shelves, UPS holder, mouse holder, and other accessories (see page 36)

### Standard Colors

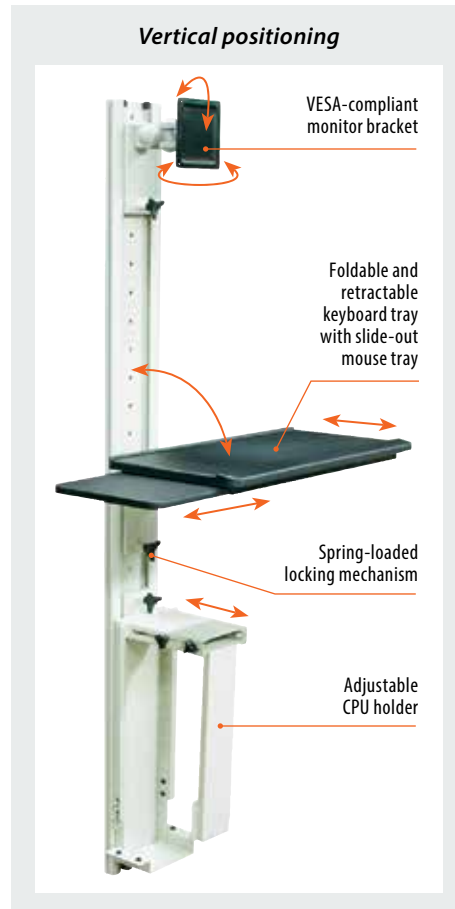

### Optional Monitor Arms for Wall Mounts

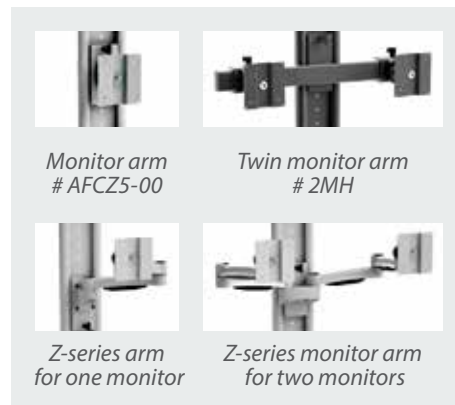

### Horizontal positioning

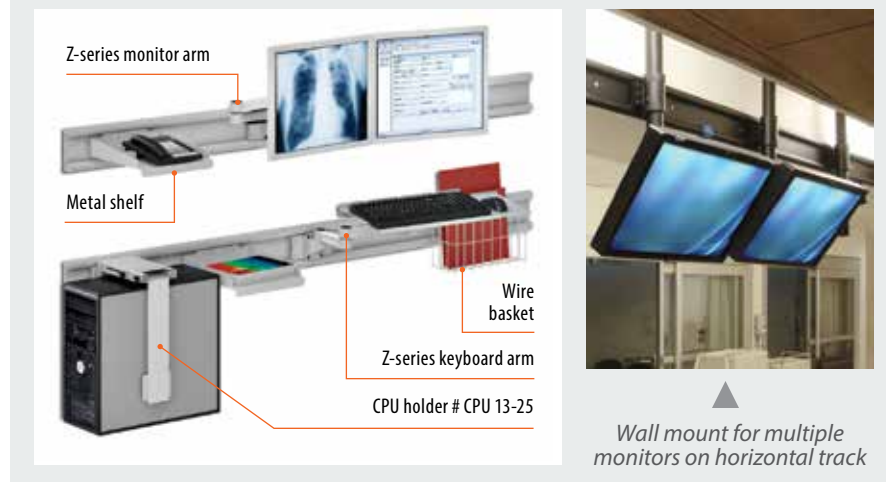

### Sample Configurations



A. Wall Mount # WM36-NH-1F-1KS-C101



B. Wall Mount # WM56-2FZ-KB82R-U-C13\_25



C. Wall Mount # WM56-1F-KBZ-Sh-C101



Configure your own Wall Mount with our INTERACTIVE BUILDER at [www.afcindustries.com/wallmount](http://www.afcindustries.com/wallmount)

## Partitions

Complete your work area using AFC Partitions. These partitions absorb sound, provide privacy and prevent interference from monitors or other light sources. They can be manufactured with a tinted or clear Plexiglas panel across the top so operators can see outside of their "cubicle."

AFC offers both free-standing partitions and partitions affixed to the floor or workstation. Our partitions can be configured to suit your needs.



### Features and Benefits

- One-inch sound-absorbing fiber with reflector on one side
- Cold-rolled 11-gauge steel frame with epoxy-powder-coated finish
- Prevents light interference
- Can be used as a tack board
- Multiple colors available (for frame colors, see page 39)
- ¼" thick free-standing base

### Specifications

- Width: 36", 48", 60", 72"
- Height from the floor: 60", 72"

### Optional

- ⅛" tinted or clear Plexiglas top
- Fiber top with removable lower metal panel and built-in continuous cable management
- Free-standing, mobile (2" twin casters), or affixed to the floor/cart

### Fabric Standard Colors



- A. Partition 60"W x 60"H with sound-absorbing fiber**
- B. Partition 60"W x 72"H with tinted Plexiglas top**



**C. Partitions affixed to the floor**



- D. Partitions affixed to the floor:**
- Light and sound barrier fiber top
  - Removable lower metal panel allows back CPU access
  - Built-in continuous cable management

## LCD Monitor Arms/ Holders

### Desktop Series

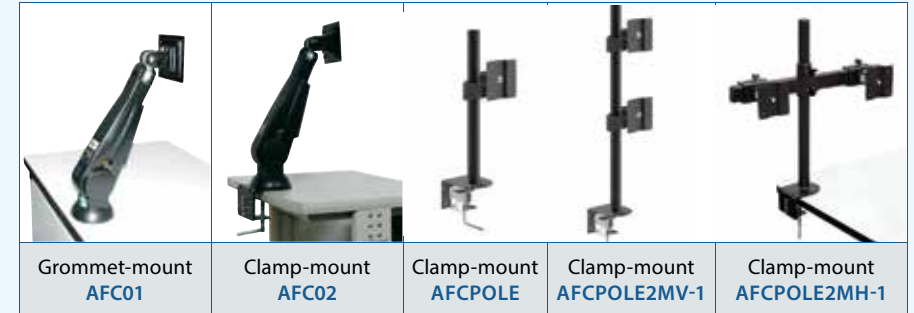

### Z-Series



### Wall Mount Series

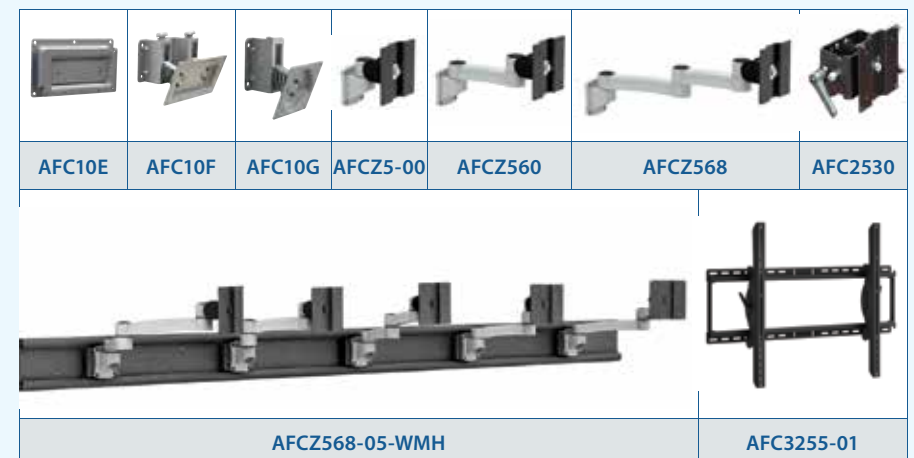

### CPU Holders

|                      |                          |
|----------------------|--------------------------|
|                      |                          |
| Desk or wall-mount   |                          |
| CPU 13-25            | CPU-09                   |
|                      |                          |
| Wall-mount CPU-CS909 | Wall-mount CPU-919       |
|                      |                          |
| Wall-mount CPU-101   | Mobile CPU Cradle CPU-02 |

### Lighting

|                       |                              |
|-----------------------|------------------------------|
|                       |                              |
| LED Task Light TAL400 |                              |
|                       |                              |
| Task Light TAL200A    | AmbiTask Light Combo AMBL001 |
|                       |                              |
| LED Backlight TAL500  |                              |

### Cable Management & Power Solutions

|                       |                                 |                                  |                                |
|-----------------------|---------------------------------|----------------------------------|--------------------------------|
|                       |                                 |                                  |                                |
| Length: 12", 24", 36" |                                 | Diameter: 1/2"                   |                                |
| Cable Manager WM201   | Wire Managers WMF100 and WMF200 | Cable Wrap WM-400                | Retractable Power Cord RPC-101 |
| A - 1 1/8"W x 1"H     |                                 |                                  |                                |
|                       |                                 |                                  |                                |
| B - 7/8"W x 1/2"H     | Length: 30", 60"                |                                  |                                |
| Cable Manager WM100   | Wire Managers WMF100 and WMF200 | Portable AC Power System PS-TL-1 | Data & Power Ports DPA-01      |

### More Accessories

|                                     |  |                     |                           |                              |
|-------------------------------------|--|---------------------|---------------------------|------------------------------|
|                                     |  |                     |                           |                              |
| Retractable Mouse Tray              | Ergonomic shape                            | Swinglift           | Retractable               | Keyboard Arm & Tray          |
| Keyboard Arm & Tray KA6000 & TR2000 | Keyboard Arm & Tray KA6000 & TR3000        | Keyboard Arm KA7001 | Keyboard Tray KB03        | Keyboard Arm & Tray WM-TR-MZ |
|                                     |  |                     |                           |                              |
| Metal Film Box FB-100               | 12"W x 14"D x 1.5"H<br>Pencil Drawer PD002 | Wire Basket WB-100  | Cup Holder MCH-100        | Mouse Holder M001            |
|                                     |  |                     |                           |                              |
| Phone Arm TA002                     | Dictation Arm TA003B                       | Air Fan FanR1-100   | Ergonomic Foot Rest FR002 | Palm Rest PAL1000            |

### Storage Accessories

|                                     |                                   |                                    |  |
|-------------------------------------|-----------------------------------|------------------------------------|--|
|                                     |                                   |                                    |  |
| 30", 36", 48", 60", 72" or 84" wide |                                   |                                    |  |
| Flipper Cabinet FC                  | Wood Clipboard Holder CLPHLD-W    | One Door Cabinet D0123             |  |
|                                     |                                   |                                    |  |
| Two Door Cabinet D0124              | Mobile Film Box FB-100            | Two Door Pedestal with Two Drawers | Mobile Pedestal P2BF16WD               |
|                                     |                                   |                                    |  |
| Metal Pedestal P2FF19MF             | Wood Pedestal with lock P3BBF19MF | Slatwall                           | Printer Shelf/Rolling Shelf EXSHR META |

**FREE on-site consultation**

At AFC we want to get it right the first time, every time, to create a custom environment for our Customers. That's why we will come to you to ensure we are maximizing your space and that everything is measured up just right. We will work with your team, at no charge to you, from the beginning to the end of your project.

**FREE project support**

Our team is here to assist you with your vision. We have the experience to help with your project and pride ourselves in going above and beyond to not just meet, but exceed your expectations.

**FREE design service**

We want to use our many years of experience creating spaces to offer you this advantage and help you go beyond your imagination. With some of the most mechanically advanced products, we will help you achieve your goals, at no additional cost to you.

**Customization**

AFC can easily customize all products to adapt to your professional and individual requirements. Whether you need help choosing the right components to configure a product or are considering a complete room redesign, our staff is committed to offering you assistance every step of the way.

**Outstanding customer support**

Our experienced sales and engineering teams are here to walk you through the process from the smallest to largest jobs. Building rapport with our customers is a driving force throughout the relationship and is maintained during the entire project including follow-up.

**LATEST TECHNOLOGIES**



**Antimicrobial paint**

AFC offers the added protection of antimicrobial powder-coat finishes on its products to provide protection against a broad spectrum of microorganisms. When applied to mobile carts, wall mounts, and work stations the risk of spreading harmful bacteria and viruses between patients and health care workers is greatly reduced, according to doctors using the antimicrobial powder coating in their hospitals and laboratories.

**High-density polyethylene (HDPE) top available with antimicrobial protection**

A new kind of antimicrobial protection upgrade is available in many of AFC's polymer sheets, slabs and massive shapes. HDPE helps products stay cleaner between cleanings and inhibits the growth of product-damaging microorganisms, including bacteria, algae and fungi on the surface. Microbe cell walls that come into contact with HDPE are destroyed on contact, without creating opportunities for adaptive or resistant strains to form. Because the antimicrobial agent is bonded at the atomic level throughout the sheet, it will not leach out of the product. This means the agent retains its effectiveness throughout the life of the product and does not harm the environment.

It is safe, non-toxic and non-hazardous to ship and handle. The product is EPA-registered and listed with the FDA as a modifier to medical devices.

Products made using AFC's polymers with HDPE are easy to clean, disinfect and keep hygienic using standard cleaning procedures. Constant use of cleaning solutions will not affect any polymer.

**STANDARD COLORS**

**Laminate**



Black



Speckled Gray



Gray



Mahogany



Wild Cherry



Natural Pear

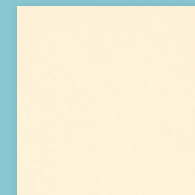

Putty

*For any other color call us at 1.800.663.3412*

**Frame**



Black

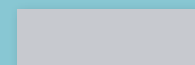

Gray

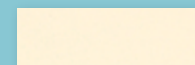

Putty



White

**Molding**



Black

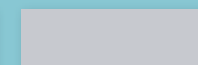

Gray

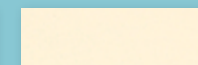

Putty

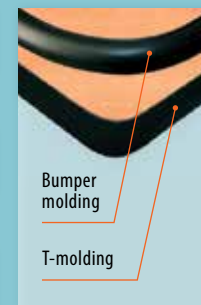

Bumper molding

T-molding

*Use our Room Layout Designer to see how you can create an ergonomic environment with AFC's products*





13-16 133<sup>rd</sup> Place • College Point • NY 11356

toll free: 1.800.663.3412  
t: 1.718.747.0237  
f: 1.718.747.0726  
[www.afcindustries.com](http://www.afcindustries.com)



We deliver our products fully assembled to ensure maximum quality and convenience for our customers.



Scan here with your smart phone to visit our website

